

user manual

EvoClean with Total Eclipse Controller

index

1.00	overview	page
1.01	Package Contents	3
1.02	Operation	3
1.03	Model Numbers and Features	4
1.04	General Specifications	5
2.00	installation	
2.01	Site Survey & Installation Requirements	5
2.02	Mounting Kit	6
2.03	Incoming Water Supply	6
2.04	Route Discharge Hose to Machine	6
2.05	Routing Pickup Tubes	7
2.06	Power Connection	7
2.07	Programming	8
3.00	maintenance	
3.01	Preparation for Maintenance	8
3.02	Maintenance for Lower Manifold, Eductor or Solenoid	8
3.03	Return Dispenser to Service	10
4.00	troubleshooting	
4.01	Problem - Cause - Solution Table	11
5.00	service parts	
5.01	Exploded Parts Diagram (cabinet)	12
5.02	Service Part Numbers (cabinet)	12
5.03	Exploded Parts Diagram (manifold)	13
5.04	Service Part Numbers (manifold)	13
6.00	warranty	
6.01	Warranty	14
6.02	Limitation of Liability	14

1.00 overview

Safety Precautions



WARNING! Please read these warnings carefully and follow all applicable local codes and regulations.

THANK YOU FOR YOUR INTEREST IN OUR PRODUCTS!

TO AVOID SERIOUS PERSONAL INJURY AND PROPERTY DAMAGE:

WEAR protective clothing and eyewear when dispensing chemicals or other materials, when working in the vicinity of chemicals, and when filling or emptying equipment.

ALWAYS read and follow all safety instructions in safety data sheets (SDS) for all chemicals.
observe all safety and handling instructions of chemical manufacturer.
dilute and dispense chemicals in accordance with chemical manufacturer's instructions.
direct discharge away from you and other persons and into approved containers.
regularly inspect equipment and keep equipment clean and properly maintained.
install using a qualified technician only, in accordance with all applicable electrical and plumbing codes.
disconnect all power to dispenser during installation, service, and/or any time dispenser cabinet is opened.

NEVER mix incompatible chemicals that pose hazards.

1.01 Package Contents

1) EvoClean Dispenser (part number varies by model)	5) Chemical Pick-up Tube Kit (optional) (part number varies by model)
2) Quick Start Guide (not shown) (P/N HYD20-08808-00)	6) Backflow Preventer (optional) (P/N HYD105)
3) Accessory Kit (not shown) (Mounting brackets and hardware)	7) Machine Interface (optional) (P/N HYD10-03609-00)
4) Inline Umbrella Check Valve Kit (not shown) (part number varies by model)	8) Total Eclipse Controller (optional) (P/N HYD01-08900-11) OR Connected Total Eclipse Controller (optional) (P/N HYDCTE-RTE1015)



EvoClean Dispensers (8, 6 and 4 product)

1.02 Operation

The EvoClean is a low maintenance, venturi-based laundry chemical dispenser. It is used with a separate Total Eclipse controller and machine interface. EvoClean is now available in configurations that can stream data directly to Hydro Connect. The EvoClean can be used for applications requiring four, six or eight products and offers an integrated flush manifold. This manual contains instructions for installing, operating and troubleshooting the dispenser.

NOTE! The EvoClean is intended for use in industrial applications. It is not suitable for domestic use, and it must not be used outside of its intended use. The product must only be used for commercial laundry operation. The manufacturer waives any responsibility arising from incorrect usage or transportation.

1.00 overview (continued)

1.03 Model Numbers and Features

EvoClean Build Options:

Number of Products: 4 = 4 Products
6 = 6 Products
8 = 8 Products

Flow Rate: L = Low Flow
H = High Flow

Check Valve Barb Size: 2 = 1/4 inch Barb
3 = 3/8 inch Barb
5 = 1/2 inch Barb

Outlet Barb Size: 3 = 3/8 inch
5 = 1/2 inch

Water Inlet Style: G = Garden Hose
J = John Guest
B = BSP

Controller Included: CON = Connected TE Controller is Included
TE = TE Controller is included
(blank) = TE Controller is not Included

Machine Interface (MI) Included: M = Machine Interface is Included
(blank) = Machine Interface is not Included

Build Example:	HYD	E12	4	L	3	5	G	TE	M
Model Builder:	Hydro Prefix	Base Model	Number of Products	Flow Rate	Check Valve Barb Size	Outlet Barb Size	Water Inlet Style	Controller Included	Machine Interface (MI) Included

Popular NA Models

HYDE124L35GTEM	HYD	E12	4	L	3	5	G	CON	M
HYDE124H35GTEM	HYD	E12	4	H	3	5	G	CON	M
HYDE124L35G	HYD	E12	4	L	3	5	G		
HYDE124H35G	HYD	E12	4	H	3	5	G		
HYDE126L35GTEM	HYD	E12	6	L	3	5	G	CON	M
HYDE126H35GTEM	HYD	E12	6	H	3	5	G	CON	M
HYDE126L35G	HYD	E12	6	L	3	5	G		
HYDE126H35G	HYD	E12	6	H	3	5	G		
HYDE128L35GTEM	HYD	E12	8	L	3	5	G	CON	M
HYDE128H35GTEM	HYD	E12	8	H	3	5	G	CON	M
HYDE128L35G	HYD	E12	8	L	3	5	G		
HYDE128H35G	HYD	E12	8	H	3	5	G		

Popular APAC Models

HYDE124L35BTEMAPAC	HYD	E12	4	L	3	5	B	CON	M
HYDE124H35BTEMAPAC	HYD	E12	4	H	3	5	B	CON	M
HYDE126L35BTEMAPAC	HYD	E12	6	L	3	5	B	CON	M
HYDE126H35BTEMAPAC	HYD	E12	6	H	3	5	B	CON	M
HYDE128L35BTEMAPAC	HYD	E12	8	L	3	5	B	CON	M
HYDE128H35BTEMAPAC	HYD	E12	8	H	3	5	B	CON	M
HYDE124L55BTEMAPAC	HYD	E12	4	L	5	5	B	CON	M
HYDE124H55BTEMAPAC	HYD	E12	4	H	5	5	B	CON	M
HYDE126L55BTEMAPAC	HYD	E12	6	L	5	5	B	CON	M
HYDE126H55BTEMAPAC	HYD	E12	6	H	5	5	B	CON	M
HYDE128L55BTEMAPAC	HYD	E12	8	L	5	5	B	CON	M
HYDE128H55BTEMAPAC	HYD	E12	8	H	5	5	B	CON	M

NOTE! Standard Total Eclipse versions of all units above are available by replacing CON with TE.

1.00 overview (continued)

1.04 General Specifications

Category	Specification
Electrical (Dispenser)	110V to 240V AC at 50-60 Hz up to 0.8 Amps
Water Pressure Rating	Minimum: 25 PSI (1.5 Bar - 0.18 mPa) Maximum: 90 PSI (6 Bar - 0.6 mPa)
Inlet Water Temperature Rating	Between 40°F and 140°F (5°C and 60°C)
Chemical Temperature Rating	Intake chemicals should be at room temperature
Cabinet Material	Front: ASA Rear: PP-TF
Environmental	Pollution: Degree 2, Temperature: 50°-160° F (10°-50° C), Maximum Humidity: 95% Relative
Regulatory Approvals	North America: Conforms to: ANSI/UL Std. 60730-1:2016 Ed. 5 Certified to: CAN/CSA Std. E60730-1 2016 Ed. 5 Global: Conforms to: 2014/35/EU Conforms to: 2014/30/EU Certified to: IEC 60730-1:2013, AMD1:2015 Certified to: EN 61236-1:2013
Dimensions	4-Product: 8.7 in (220 mm) High x 10.7 in (270 mm) Wide x 6.4 in (162 mm) Depth 6-Product: 8.7 in (220 mm) High x 14.2 in (360 mm) Wide x 6.4 in (162 mm) Depth 8-Product: 8.7 in (220 mm) High x 22.2 in (565 mm) Wide x 6.4 in (162 mm) Depth

2.00 installation

2.01 Site Survey & Installation Requirements



CAUTION! Before an installation takes place it is advisable to complete a site survey to ensure the EvoClean can be installed in a position that meets all of the requirements listed below.

- Unit is to be installed by a trained technician; all local and national electrical and water regulations are to be observed.
- Unit must not be installed near areas that suffer excess temperature changes, direct sunlight, frost or moisture of any kind.
- Area must be free of high levels of electrical noise.
- Ensure the unit can be mounted in an accessible position above the height of the required discharge location.
- Ensure there is an appropriate power source within the reach of the 8-foot standard power cable.
- Unit must be mounted on a suitable wall, that is flat and perpendicular to the floor.
- The unit location should be well lit for any maintenance and free of high levels of dust / air particulates.
- Scheduled maintenance should be carried out on the dispenser at least once per year.
- A locally approved back-flow prevention device - not provided - may be required for safe and legal operation. Hydro Systems offers an approved back-flow prevention device as an option, if one is needed (part number HYD105).

2.00 installation (continued)

2.02 Mounting Kit

1) Choose a location near to the laundry machine. Use the mounting bracket to mark the appropriate mounting location and as a hole template to mark the securing holes.

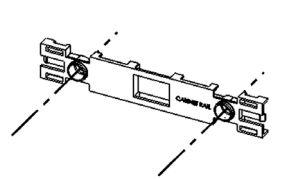

4 or 6 product: 1 bracket

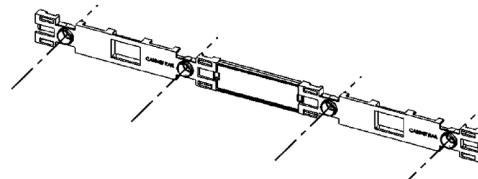

8-product: 2 brackets and joiner

2) Wall anchors are provided, please ensure they are appropriate to the wall/surface being mounted to.

3) Mount the dispenser onto the mounting bracket. Push down the clips to secure the unit.

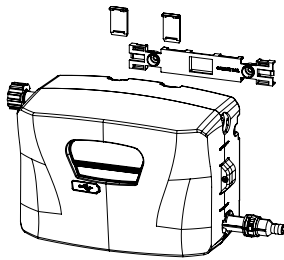

Hang unit on bracket.

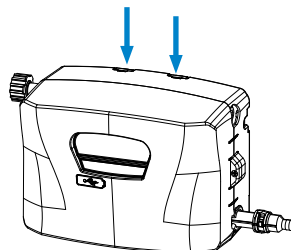

Push down clips.

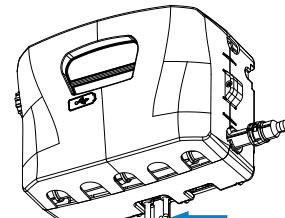

Secure with screw.

4) Secure the dispenser at the bottom, with the remaining screw provided.

NOTE! Please secure any cables so that they do not create a hazard for the operator.

2.03 Incoming Water Supply



WARNING! Ensure the incoming water supply hose is supported to prevent unnecessary stress on the inlet fitting.

- 1) Connect incoming water supply using fittings provided. This will either be a 3/4" female Garden Hose fitting, or a 1/2" O.D. push-fit connector.
- 2) A locally approved back-flow prevention device - not provided - may be required for safe and legal operation. Hydro Systems offers an approved back-flow prevention device as an option, if one is needed (part number HYD105).
- 3) Although it is possible to have the water inlet on either side of the dispenser, the outlet will always need to be on the right.



2.04 Route Discharge Hose to Machine

- 1) Connect outlet (see above) to the washing machine using 1/2" ID flexible braided PVC hose.
- 2) Secure PVC hose to barb with a hose clamp.

2.00 installation (continued)

2.05 Routing Pickup Tubes

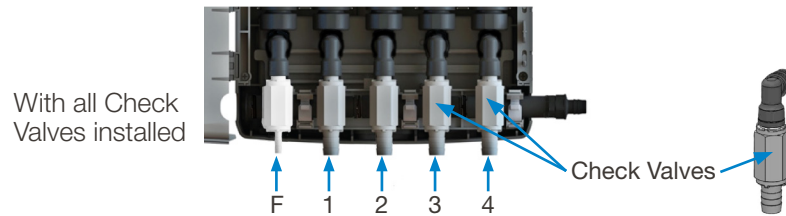

- 1) Open cabinet.
- 2) The check valves are supplied detached, in a bag with the unit. **To prevent damage to the dispenser, install hoses to the check valves before connecting the check valves to the manifold!**
- 3) The eductors are designated from left to right in the following order:
 - 4-product units (single cabinet): F, 1, 2, 3, 4
 - 6-product units (single cabinet): F, 1, 2, 3, 4, 5, 6
 - 8-product units (twin cabinet): F, 1, 2, 3, 4 - 5, 6, 7, 8
- 4) Measure the distance of the hose route to be used, from the eductor to the base of the respective chemical container.
- 5) Cut the 3/8" ID flexible PVC Hose tube to that length. (Alternative check valve and hose options are available. Contact Hydro Systems for further information.)
- 6) Push the PVC hose on to the detached check valve and secure with cable tie, then push the check valve elbow into the eductor and secure with the push-on clip, as shown in the diagrams below.

 **WARNING! Do not connect any chemical hoses to the (F) Flush vent position!**

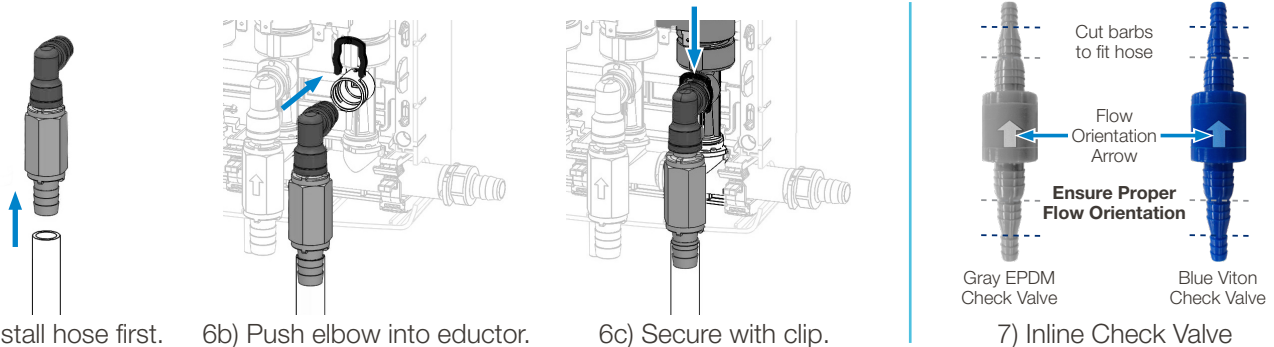

- 7) Install the in-line check valves between the dispenser and chemical container, as close to the container as possible. They must be installed in a vertical orientation  not at an angle or horizontally; and the flow must match the orientation arrow on the valve body (as shown in figure 7). Cut barbs to the largest size compatible with the chemical intake tubing.

NOTE: Gray check valves have an EPDM seal and must be used with **alkaline** products only.
Blue check valves have a Viton seal and should be used for **all other** chemicals.

- 8) Place the inlet hose into the container, or if using a closed-loop packaging connect the inlet hose to the container.

 **WARNING!** Do not attempt to "tee" chemical intake hoses to feed multiple eductors or dispensers! Loss of prime or insufficient chemical feed may result. Always run an individual intake hose to the chemical container.

2.06 Power Connection

- 1) Install the Total Eclipse controller or Connected to Total Eclipse controller and the Machine Interface using the separate instruction sheets for those products.
- 2) Connect the EvoClean dispenser to the Total Eclipse controller or Connected to Total Eclipse controller via the pre-wired J1 cable coming from the dispenser.
- 3) Connect the EvoClean's power cord to an appropriate supply providing 110V to 240V AC at 50-60 Hz up to 0.8 Amps.
- 4) It is a legal requirement to allow disconnection of the appliance from the power supply after installation. The disconnection may be achieved by having the plug accessible or by incorporating a switch in fixed wiring in accordance with wiring rules.

 **WARNING!** Wires and hoses left hanging loose may be a tripping hazard, and could result in equipment damage. Ensure all cables are secure. Be sure the tubing will be out of the way of walkways and will not impede motion required in the area. Creating a low place in the run of tubing will minimize drainage from the tubing.

2.00 installation (continued)

2.07 Programming

- 1) Programming will be accomplished using the connected Total Eclipse controller or Connected to Total Eclipse controller. Please consult the appropriate controller documentation to complete this step.

3.00 maintenance



WARNING! Before you perform any maintenance, disconnect the incoming power source.

3.01 Preparation

- 1) Unplug the power cable from wall to disconnect incoming main power supply.
- 2) Shut off the water supply to the system and disconnect the inlet water supply line and outlet discharge tubing.
- 3) Use a Phillips head screwdriver to loosen the screw and open the front cover of the enclosure.
- 4) Disconnect the check valves from the eductors (see step 6 in section 2.0.5 on the previous page) and drain chemical lines back into their containers.

NOTE: If you going to remove any solenoid valves, use a 3/8" Allen wrench inside the water inlet swivel stem to remove it from the upper manifold. This will allow you to lift the upper manifold later without interference with the cover.



6-product EvoClean
with tools for maintenance

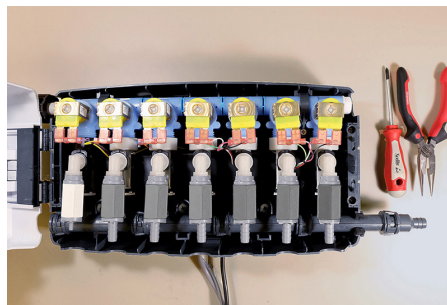

6-product EvoClean
with front cover open

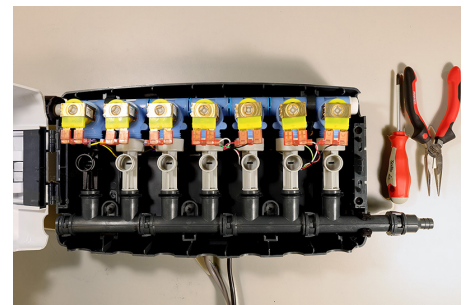

6-product EvoClean -
Prepared for maintenance

3.02 Maintenance for Lower Manifold, Eductor or Solenoid

- 1) Perform 3.01 Preparation, then remove the Phillips screws holding the lower manifold in the cabinet, as shown below.
- 2) Pivot the manifold assembly upward around the upper manifold, to give some clearance for disconnecting the lower manifold. (If the manifold is difficult to turn upward, slightly loosen the two upper manifold clamp screws shown in step 6.)
- 3) Pull off the clips holding the lower manifold to the eductors and remove the lower manifold.

NOTE: With APAC units, ensure the ball and spring of the non-return valves are properly retained in the lower manifold.

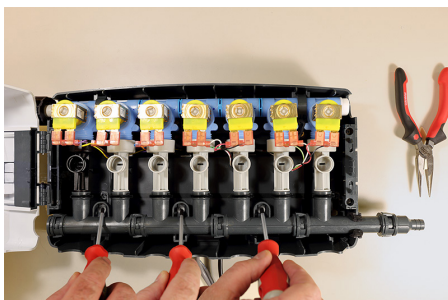

1) Remove lower manifold screws

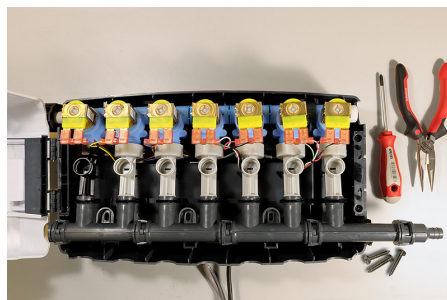

2) Lift lower manifold

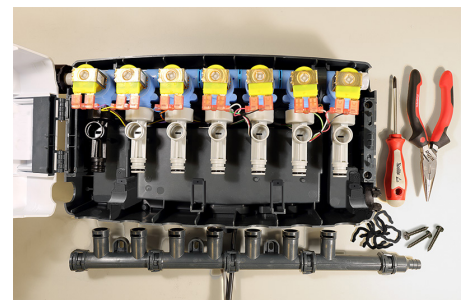

3) Pull the clips, remove lower manifold

(continued)

3.00 maintenance (continued)

3.02 Maintenance for Lower Manifold, Eductor or Solenoid (continued)

4) Inspect the manifold, it's joint O-rings, and the eductor O-rings for damage and replace any damaged parts, as necessary.

(To maintenance an eductor or solenoid, proceed to step 5. Otherwise skip to step 15 to begin reassembly.)

5) Unscrew the eductor from the upper manifold and remove it as shown to the right.

Inspect the eductor and its O-ring for damage. Repair or replace parts as needed.

(To maintenance a solenoid, proceed to step 6.

Otherwise skip to step 14 to begin reassembly.)

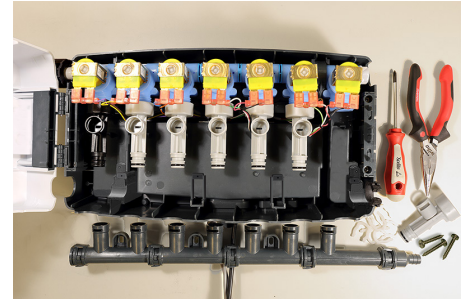

4) Unscrew eductor and inspect

6) Unscrew the screws holding the two half-circle clamps that secure the upper manifold.

7) Rotate the upper manifold clamps back, out of the way.

8) Use pliers to carefully unplug the solenoid electrical connections. **(CAUTION! Keep a careful record of what color wires you disconnect from each solenoid connector, so when you need to reconnect them in post-maintenance reassembly you will be 100% sure which color wire goes where. Perhaps taking cell-phone photos would be a good way to keep track.)**

9) Lift the upper manifold to provide clearance to unscrew solenoid. (Notice water inlet swivel fitting has been removed.)

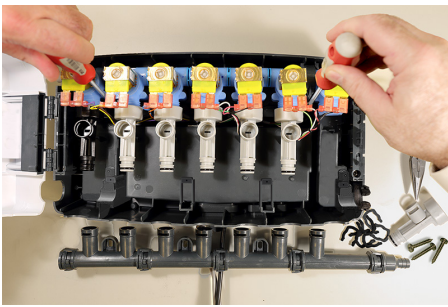

6) Remove upper manifold screws



7) Rotate clamps up

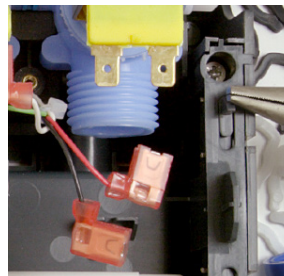

8) Unplug solenoid electrical connections

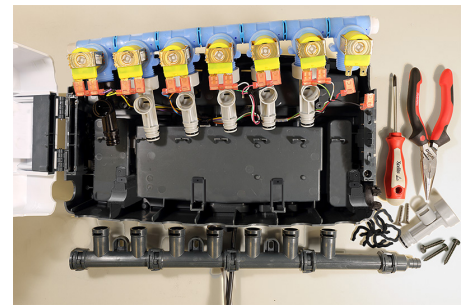

9) Lift manifold to provide clearance

10) Unscrew the solenoid from the upper manifold and remove it. Inspect Solenoid and O-ring. Repair or replace as needed.

(Note: Eductor 6 is used in this example. Other positions may require multiple eductor and solenoid removal.)

11) Screw on the new replacement or existing solenoid. Tighten enough to prevent leaks and to orient outlet downward.

12) Lower the upper manifold back into position, secure with half-circle clamps (which can be pushed forward from the back of the cabinet if they are hard to grasp from the front) and reconnect the solenoid electrical connections.

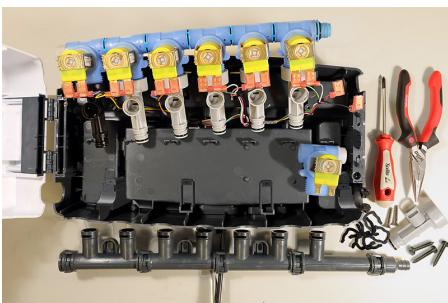

10) Unscrew solenoid and inspect



11) Attach new or existing solenoid

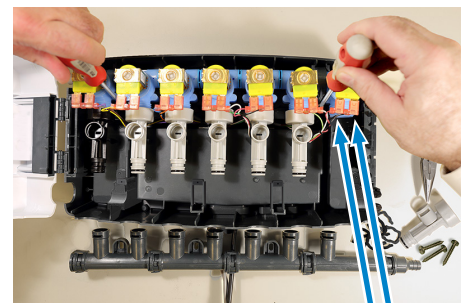

12) Secure manifold, reconnect solenoid

3.00 maintenance (continued)

- 13) Screw on the new replacement or existing eductor. Tighten enough to prevent leaks and to orient intake outward.
- 15) Reattach the lower manifold, pushing it onto the eductors, and secure the manifold to the eductors using the clips.

(Note: With APAC units, ensure the ball and spring non-return valves are properly seated in the lower manifold before reassembly.)

- 16) Secure the lower manifold to the back cover with the screws you removed earlier.

(Note: If you loosened the upper manifold screws, and have not tightened them yet, tighten them now.)

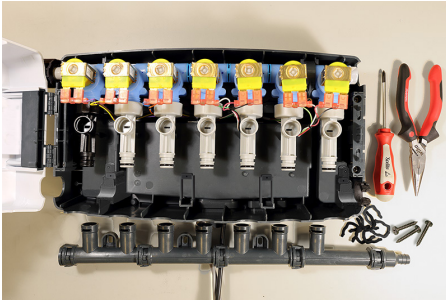

14) Attach new or existing eductor

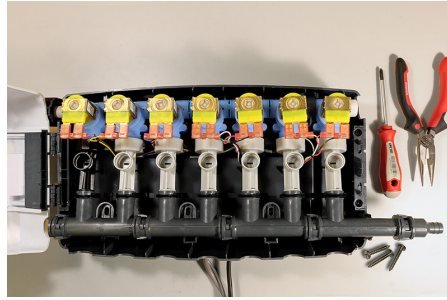

15) Attach lower manifold to eductors

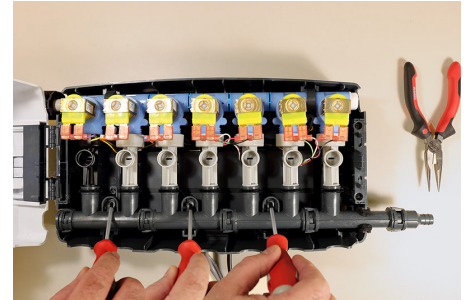

16) Secure lower manifold

3.03 Return Dispenser to Service

- 1) Returning Dispenser to Service: (Not shown)
 - a. Reconnect and secure the flush and chemical intake check valves to the dispenser. (See Step 6 in Section 2.0.5.)
 - b. If you removed it for solenoid maintenance, reconnect the water inlet swivel stem with a 3/8" Allen wrench.
 - c. Reconnect the water inlet and outlet tubing and turn on the incoming water supply. Check for leaks.
 - d. Reconnect the power cord to an appropriate supply providing 110V to 240V AC at 50-60 Hz up to 0.8 Amps.
 - e. Follow the procedure in the Total Eclipse controller menu for priming the chemical pickup lines. Check for leaks again.

(Troubleshooting Table shown on next page.)

4.00 troubleshooting

Problem	Cause	Solution
1. Dead Total Eclipse controller display	a. No power from source.	<ul style="list-style-type: none"> • Check for power at source. • Check the J1 cable connection at the controller. For NA units only: • Ensure the wall power transformer is delivering 24 VDC.
	b. Defective PI PCB, J1 cable or controller.	<ul style="list-style-type: none"> • Check operation of each component, replace as needed.
2. No flow of water from the outlet of the dispenser upon receipt of signal or prime (for all products)	a. Water source is turned off.	<ul style="list-style-type: none"> • Restore water supply.
	b. Water inlet screen/filter is clogged.	<ul style="list-style-type: none"> • Clean or replace water inlet screen/filter.
	c. Defective PI PCB, J1 cable or controller.	<ul style="list-style-type: none"> • Check operation of each component, replace as needed.
3. No flow of water from the outlet of the dispenser upon receipt of signal or prime (for some but not all products)	a. Loose solenoid connection or failed solenoid.	<ul style="list-style-type: none"> • Check solenoid connections and voltage at solenoid.
	b. Defective J1 cable.	<ul style="list-style-type: none"> • Check J1 cable operation and replace as needed.
	c. Clogged eductor	<ul style="list-style-type: none"> • Check eductor and clean or replace as needed,
4. No flow of water from the outlet of the dispenser upon receipt of signal (but products prime OK)	a. Product(s) not calibrated	<ul style="list-style-type: none"> • Calibrate products with TE controller as needed.
	b. No washer signal, or signal wire is loose.	<ul style="list-style-type: none"> • Verify washer program and check signal wire connections.
	c. Damaged J2 cable.	<ul style="list-style-type: none"> • Check J2 cable operation and replace as needed.
	d. Defective Machine Interface (MI), J2 cable, or controller.	<ul style="list-style-type: none"> • Check operation of each component, replace as needed.
5. Not counting loads	a. "Count Pump" not running.	<ul style="list-style-type: none"> • Ensure the "Count Pump" is selected properly, has a pump amount and that it is getting a signal to run. • Check water inlet hoses for kinks or obstructions, repair or replace as needed. • Check water inlet screen for obstruction, clean or replace as needed. • If the solutions above do not fix the issue, take measures to boost the water pressure above 25 PSI.
6. Insufficient or incomplete draw of chemical.	a. Insufficient water pressure.	<ul style="list-style-type: none"> • Check water inlet hoses for kinks or obstructions, repair or replace as needed. • Check water inlet screen for obstruction, clean or replace as needed. • If the solutions above do not fix the issue, take measures to boost the water pressure above 25 PSI.
	b. Clogged chemical check valve.	<ul style="list-style-type: none"> • Replace the clogged check valve assembly.
	c. Clogged eductor.	<ul style="list-style-type: none"> • Isolate the unit from the water supply, locate the troubled eductor, and replace the eductor.
	d. Incorrect pick-up tubing installation.	<ul style="list-style-type: none"> • Check pickup tubing for kinks or loops. Ensure that the tubing is installed below the fluid level in the container.
7. Continuous flow of water while dispenser is idle.	a. Debris in solenoid valve.	<ul style="list-style-type: none"> • Ensure inlet strainer is attached and replace affected solenoid.
	b. Defective PI PCB or J1 Cable.	<ul style="list-style-type: none"> • Check operation of each component, replace as needed.
8. Loss of chemical prime or water entering the chemical container.	a. Failed eductor check valve and/or failed in-line umbrella check valve.	<ul style="list-style-type: none"> • Replace failed valve(s) and check chemical compatibility.
	b. Air leak in system.	<ul style="list-style-type: none"> • Find and repair any air leaks in the system.
9. Water or chemical leak	a. Chemical attack or damage to a seal.	<ul style="list-style-type: none"> • Isolate the unit from the water supply, locate the exact source of the leak and replace any damaged seals and components.
10. Incomplete delivery of chemical to the washer.	a. Insufficient flush time.	<ul style="list-style-type: none"> • Increase the flush time (rule of thumb is 1 second per ft).
	b. Kinked or damaged delivery tubing.	<ul style="list-style-type: none"> • Remove any kinks and/or replace delivery tubing as needed.

5.00 service parts



WARNING! Components shown on the following pages should only be replaced by a competent engineer.

Any components not listed within this section should not be attempted to be replaced without the advice of Hydro Systems. (Any unauthorized attempts to repair the unit will invalidate the warranty.)

Before any maintenance, disconnect the incoming power source!

5.01 Exploded Parts Diagram (cabinet)

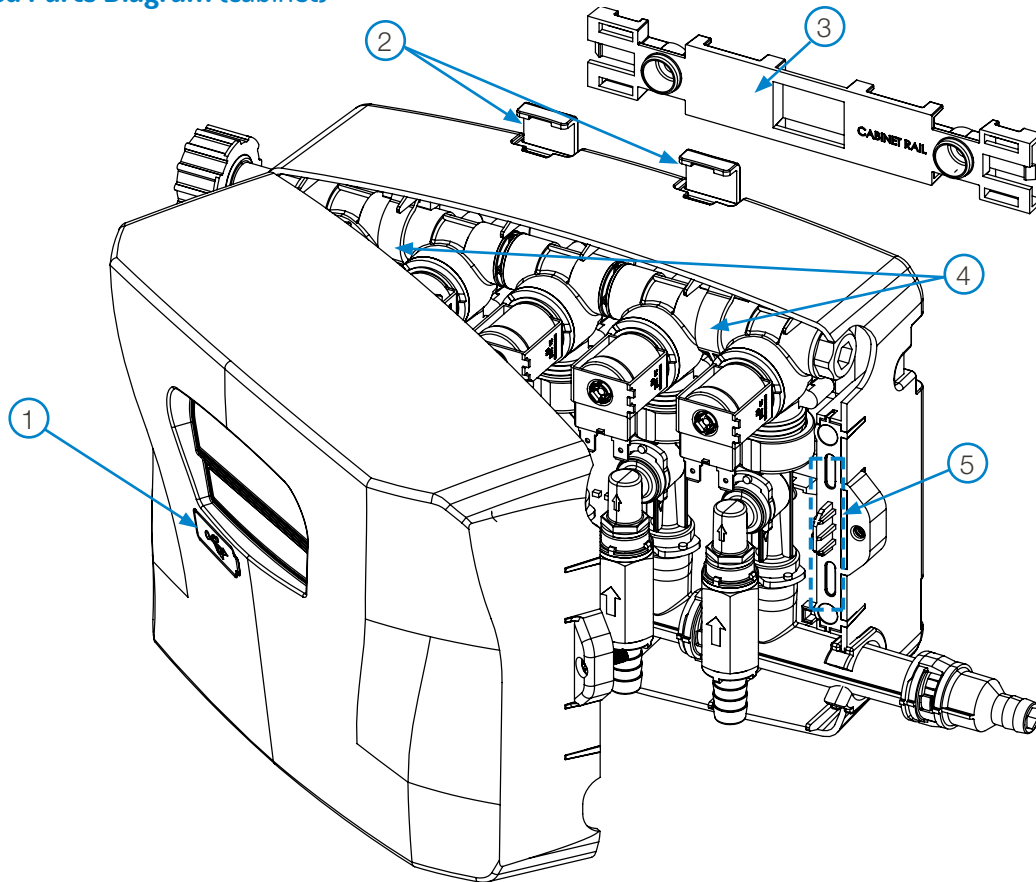

5.02 Service Part Numbers (cabinet)

Reference	Part #	Description
1	HYD10097831	USB Port Cover
2	HYD10098139	Wall Bracket Clip Kit (Contains 2 wall bracket clips)
3	HYD10094361	Wall Bracket
4	HYD10098136	Top Manifold Clip Kit (Contains 2 manifold clips, 2 screws and 2 washers) The 4-product and 6-product models use 1 kit, while the 8-product model uses 2 kits.
5	HYD10099753	Kit, EvoClean Lock Mk2 (1)
Not Shown	HYD10098944	Front Cover Label Pack
Not Shown	HYD10099761	24VDC Power Supply Kit

5.00 service parts (continued)

5.03 Exploded Parts Diagrams (manifold)

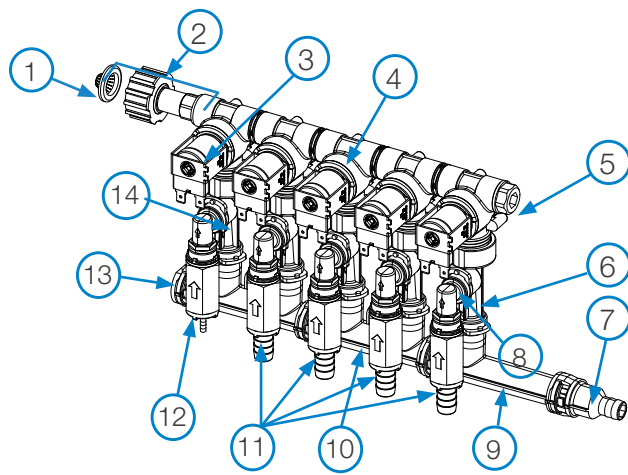

5.03 Manifold Parts

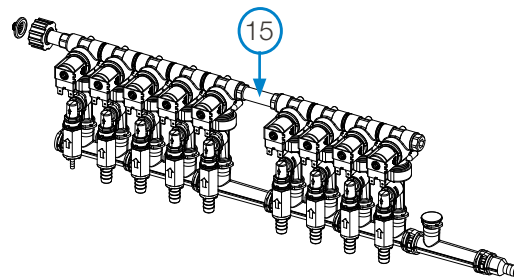

5.03 Twin-Cabinet Manifold Parts

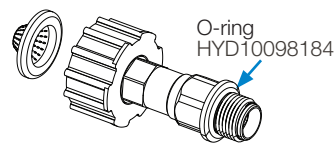

Ref. 2 Detail

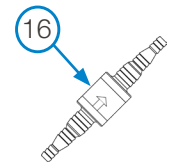

O-ring
HYD10098128

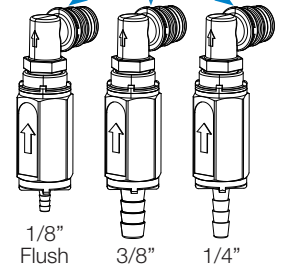

Ref. 12 & 11 Detail
(Other barb sizes available on request)

5.04 Service Part Numbers (manifold)

Reference	Part #	Description
1	HYD238100	Strainer Washer
2	HYD10098177	3/4" Garden Hose Water Inlet Assembly (includes Strainer Washer)
	HYD90098379	3/4" British Standard Pipe (BSP) Water Inlet Assembly (includes Strainer Washer)
	HYD10098184	EPDM O-ring, Size #16 (10 pack) - Not shown, used on Ref. 2, 3, 4, 5 and 15
3	HYD10095315	Solenoid Water Valve, 24V DC
	HYD10098193	EPDM Washer, 1/8 in x 1 in (10 pack) - Not shown, used on Ref. 3
4	HYD10098191	Valve Nipple Assembly (includes 2 O-rings)
5	HYD10075926	Upper Manifold End Plug
6	HYD10098196	Low Flow Eductor - 1/2 GPM
	HYD10098195	High Flow Eductor - 1 GPM
	HYD10098128	Aflas O-ring, Size #14 (10 pack) - Not shown, used on Ref. 6, 11 and 12
7	HYD90099387	1/2" Hose Barb (standard)
	HYD90099388	3/8" Hose Barb (optional)
8	HYD10098185	EvoClean Clip - Kynar (10 Pack), used on Ref. 6, 11 and 12
9	HYD90099384	Single-port Manifold
	HYD10099081	Aflas O-ring, Size 14mm ID x 2mm (10 pack) - Not shown, used on Ref. 9, 10 and 14
10	HYD90099385	Double-port Manifold
11	HYD10098186	Eductor Check Valve and Elbow Assembly, 1/4" Barb (PVC, Aflas, Teflon, Hastelloy with Kynar Elbow)
	HYD10098187	Eductor Check Valve and Elbow Assembly, 3/8" Barb (PVC, Aflas, Teflon, Hastelloy with Kynar Elbow)
	HYD10098197	Eductor Check Valve and Elbow Assembly, 1/2" Barb (PVC, Aflas, Teflon, Hastelloy with Kynar Elbow)
12	HYD10098188	Flush Check Valve and Elbow Assembly, 1/8" Barb (NOT for chemical connection!)
13	HYD90099390	Lower Manifold End Plug
14	HYD10097801	Flush Eductor - 1 GPM
15	HYD10075904	Pipe Nipple
16	HYD10099557	Inline Check Valve Kit (6 -pack: 4 Blue Viton / 2 Gray EPDM) for Chemical Intake Tube, 1/4"-3/8"-1/2" barbs
	HYD10099558	Inline Check Valve Kit (8 -pack: 6 Blue Viton / 2 Gray EPDM) for Chemical Intake Tube, 1/4"-3/8"-1/2" barbs
	HYD10099559	Inline Check Valve Kit (10 -pack: 8 Blue Viton / 2 Gray EPDM) for Chemical Intake Tube, 1/4"-3/8"-1/2" barbs

(continued)

5.00 service parts (continued)

5.04 Service Part Numbers (manifold)

Reference	Part #	Description
Not Shown	HYD90099610	Footvalve Kit, Viton, with Screen, Blue, 4 valves, 1/4"-3/8"-1/2" barbs
Not Shown	HYD90099611	Footvalve Kit, Viton, with Screen, Blue, 6 valves, 1/4"-3/8"-1/2" barbs
Not Shown	HYD90099612	Footvalve Kit, Viton, with Screen, Blue, 8 valves, 1/4"-3/8"-1/2" barbs
Not Shown	HYD90099613	Footvalve Kit, EPDM, with Screen, Gray, 4 valves, 1/4"-3/8"-1/2" barbs
Not Shown	HYD90099614	Footvalve Kit, EPDM, with Screen, Gray, 6 valves, 1/4"-3/8"-1/2" barbs
Not Shown	HYD90099615	Footvalve Kit, EPDM, with Screen, Gray, 8 valves, 1/4"-3/8"-1/2" barbs
Not Shown	HYD10098189	Chemical Intake Tubing Kit, one 7-foot length of 3/8" braided PVC tubing and 2 clamps
Not Shown	HYD10098190	Chemical Intake Tubing Kit, one 7-foot length of 1/4" braided PVC tubing and 2 clamps
Not Shown	HYD90099599	Optional Kit, Non-Return Valve (NRV) - 4 Product
Not Shown	HYD90099600	Optional Kit, Non-Return Valve (NRV) - 6 Product
Not Shown	HYD90099597	Optional Kit, Non-Return Valve (NRV) - 8 Product

6.00 warranty

6.01 Limited Warranty

Seller warrants solely to **Buyer** the Products will be free from defects in material and workmanship under normal use and service for a period of one year from the date of completion of manufacture. This limited warranty does not apply to (a) hoses; (b) and products that have a normal life shorter than one year; or (c) failure in performance or damage caused by chemicals, abrasive materials, corrosion, lightning, improper voltage supply, physical abuse, mishandling or misapplication. In the event the Products are altered or repaired by **Buyer** without **Seller's** prior written approval, all warranties will be void.

No other warranty, oral, express or implied, including any warranty of merchantability or fitness for any particular purpose, is made for these products, and all other warranties are hereby expressly excluded.

Seller's sole obligation under this warranty will be, at **Seller's** option, to repair or replace F.O.B. **Seller's** facility in Cincinnati, Ohio any Products found to be other than as warranted.

6.02 Limitation of Liability

Seller's warranty obligations and **Buyer's** remedies are solely and exclusively as stated herein. **Seller** shall have no other liability, direct or indirect, of any kind, including liability for special, incidental, or consequential damages or for any other claims for damage or loss resulting from any cause whatsoever, whether based on negligence, strict liability, breach of contract or breach of warranty.



Hydro Systems
3798 Round Bottom Road
Cincinnati, OH 45244

Phone 513.271.8800
Toll Free 800.543.7184
Fax 513.271.0160
Web hydrosystemsco.com

HYD10098182 Rev I 10/22